

REV.	DATE	DESCRIPTION	DATE
A	31/07/03	DRIFT	

NOTES:

1. MATERIAL: PLYWOOD.
2. FINISH:
3. DIMENSIONS: DIMENSIONS ARE IN MILLIMETERS.
4. CONTROL CHARACTERISTICS (■).
5. TOLERANCES: UNLESS OTHERWISE SPECIFIED, ANGULAR ±1°
DECIMALS XX ±0.3
X:XXX±0.09

DETAIL OF P
SCALE 2:1

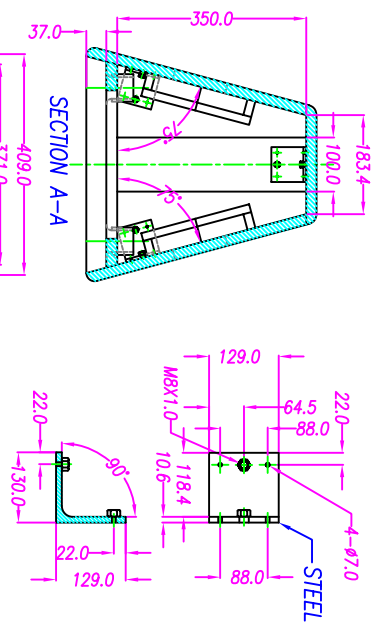

SECTION A-A

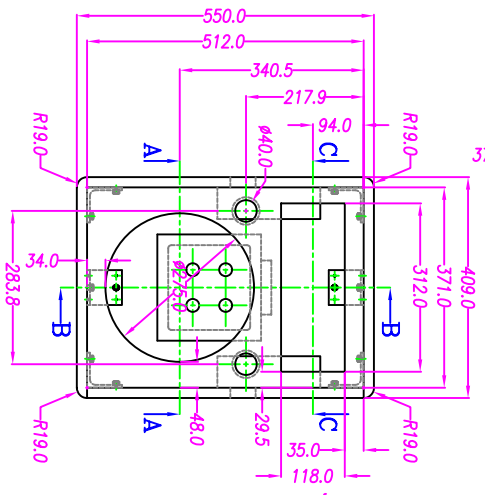
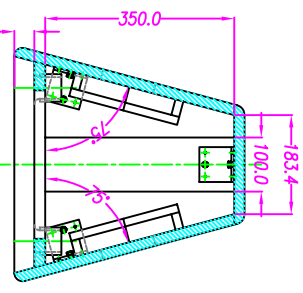

FRONT VIEW

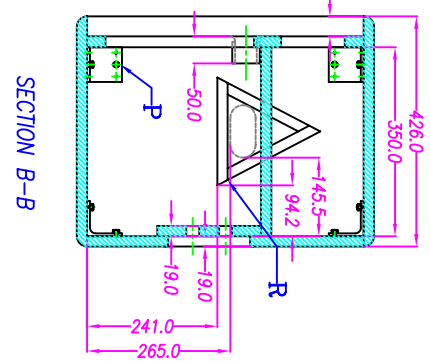

SECTION B-B

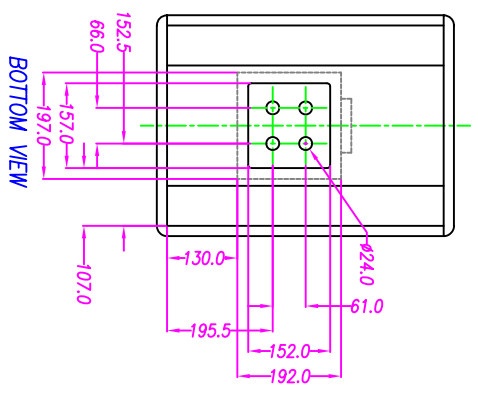

BOTTOM VIEW

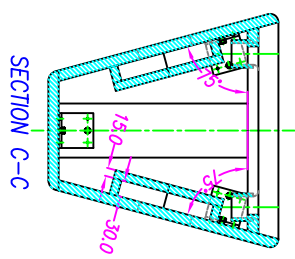

SECTION C-C

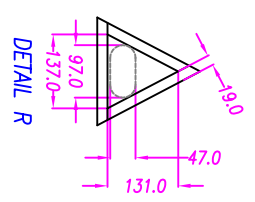

DETAIL R

THIRD ANGLE PROJECTION		ENGINEER	DATE	P.AUDIO SYSTEM CO.,LTD. BANGKOK, THAILAND	
UNLESS OTHERWISE SPECIFIED INTERPRET THIS DRAWING PER ANSI Y14.5M-1982		Q.C.	31/07/03	DESCRIPTION IS-H1202	
NOTICE P.AUDIO PROPRIETARY RIGHTS ARE INCLUDED HEREIN. THIS INFORMATION MAY NOT BE COPIED, TRANSMITTED OR DISCLOSED EXCEPT AS AUTHORIZED BY P.AUDIO SYSTEM CO.,LTD.		APPROVED	DATE	SCALE	REV.
			31/07/03	1:8	A
				A3	
				PT	
				IS-H1202	

E12-300S
BM-D440
PH-3616

